

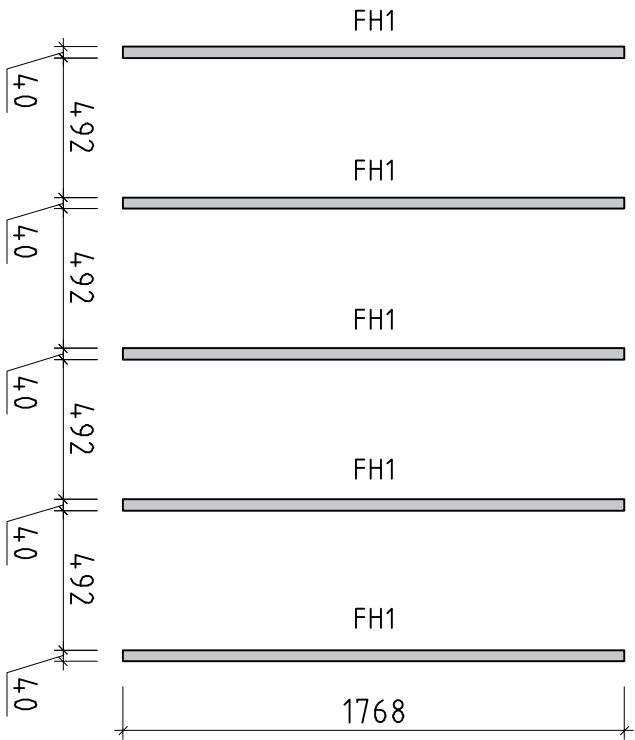

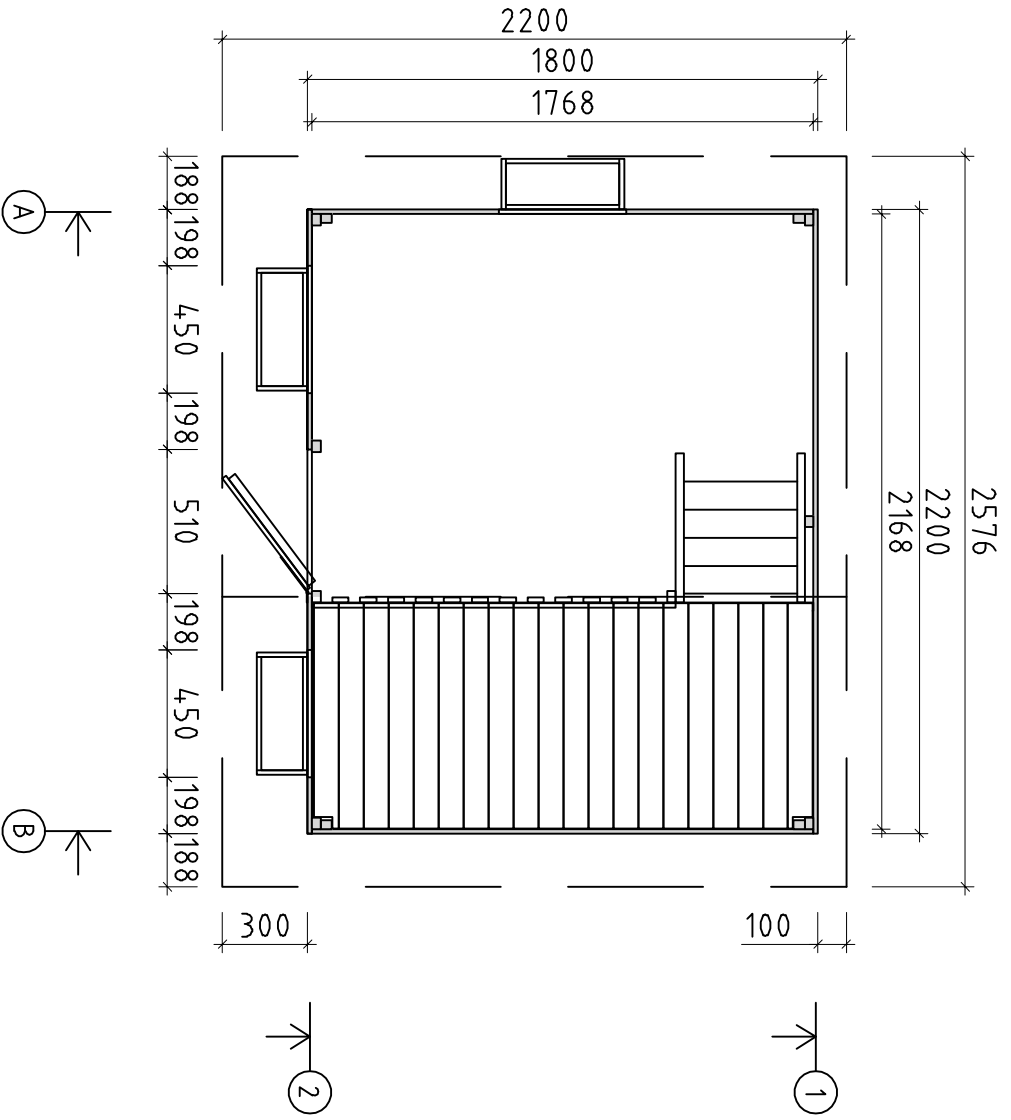

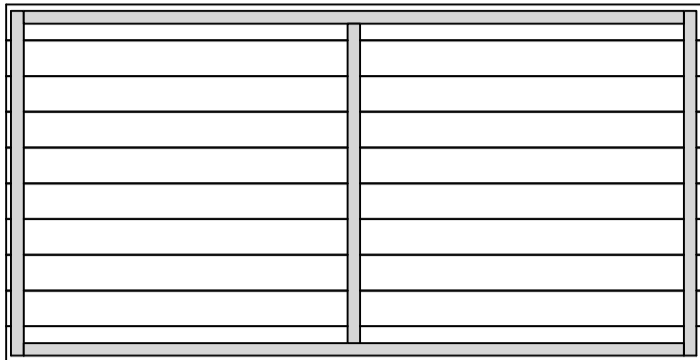

Lois 220x180 16

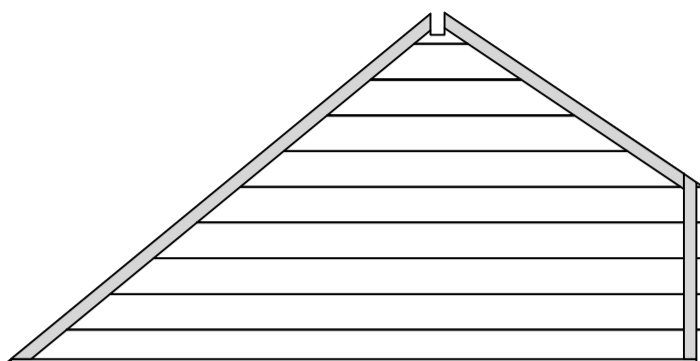
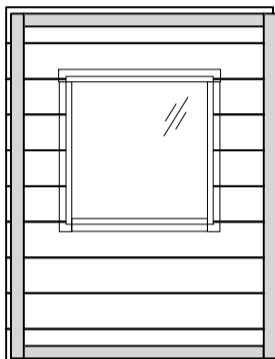
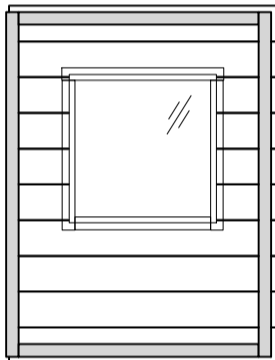
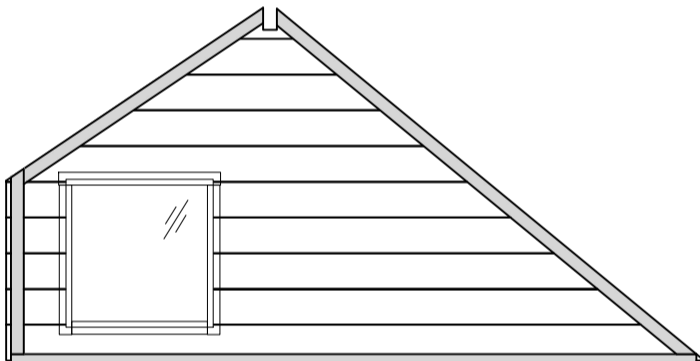
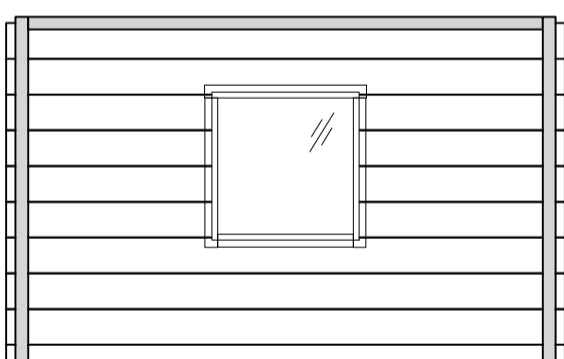
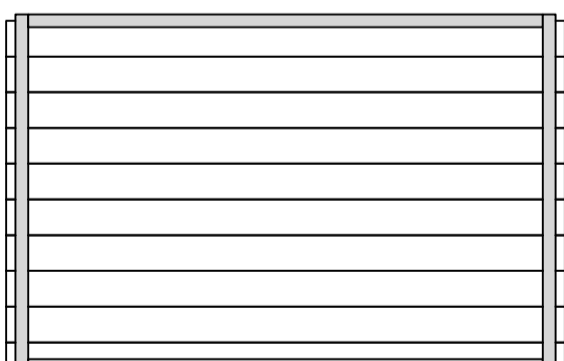
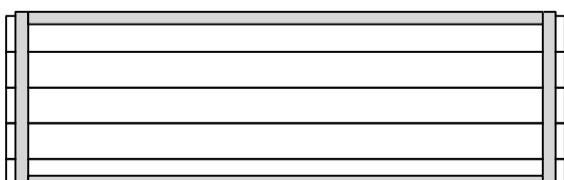
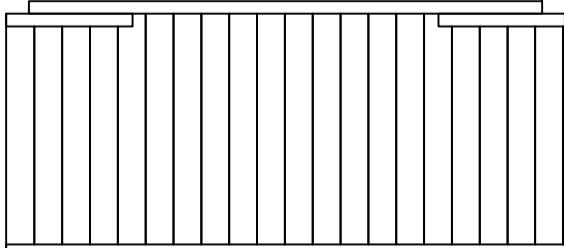

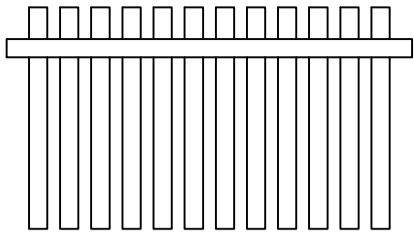
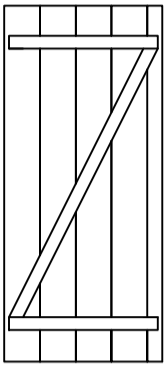
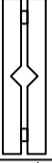
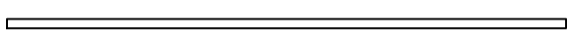
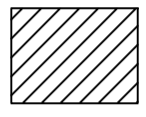
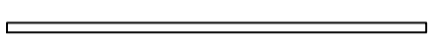
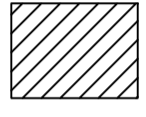
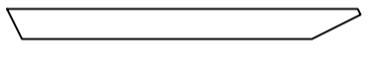
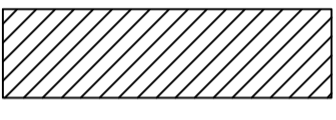
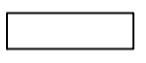
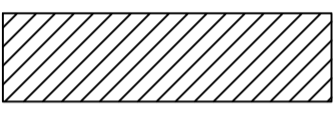
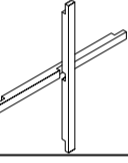

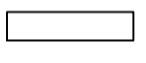
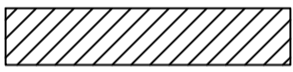

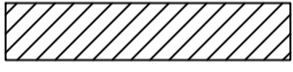
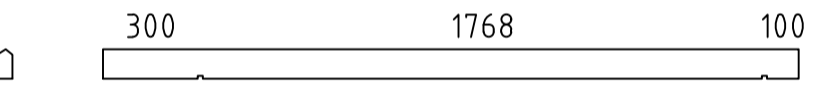
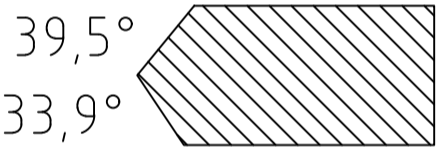
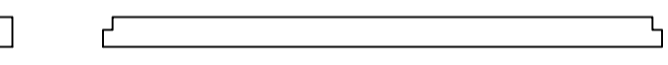
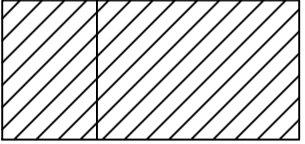
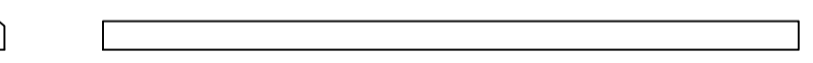
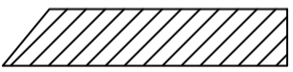
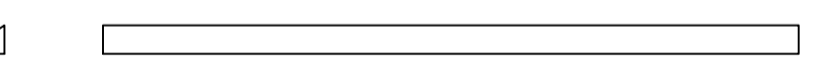
Lola 220x180 16

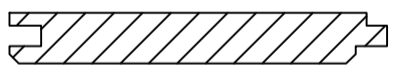
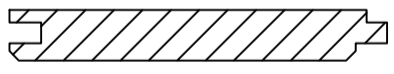
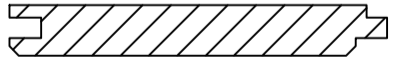
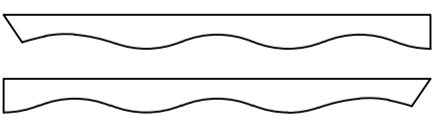
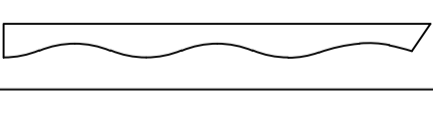
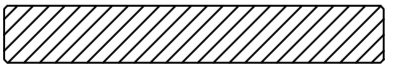
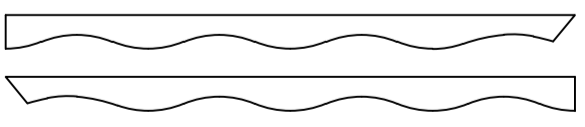
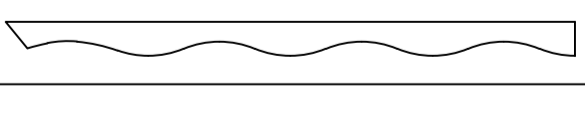
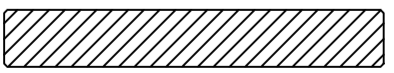
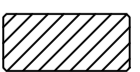
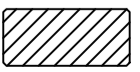
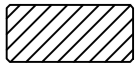
Grundplan/Plan

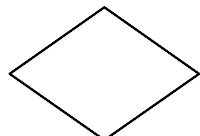
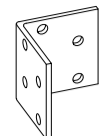
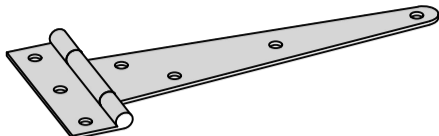
Pos	Teileliste/Specification Lola 220x180 16		Stck Pcs.	Profil Profile (mm)	Länge Length (mm)
EL1 Wand/Wall 1			1	2200x1130	
EL2 Wand/Wall 1			1	2200x1135	
EL3 Wand/Wall 2 mit Fenster/with window			1	855x1130	
EL4 Wand/Wall 2 mit Fenster/with window			1	855x1130	
EL5 Wand/Wall 2 mit Fenster/with window			1	2200x1135	
EL6 Wand/Wall A mit Fenster/with window			1	1768x1150	
EL7 Wand/Wall B			1	1768x1150	
EL8 Wand/Wall B			1	1768x579	
EL9 Balkon boden/ Balcony floor			1	1768x799	
Kood	Lola 220x180	Materjal	File	Lola 220x180 16.dwg	Leht 1/3

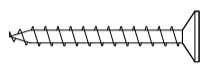
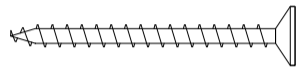
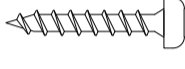
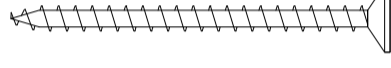
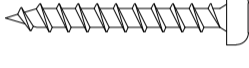
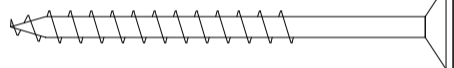
Pos	Teileliste/Specification Lola 220x180 16		Stck Pcs.	Profil Profile (mm)	Länge Length (mm)
	EL 10 Geländer/Railing		1	1282x700	
	EL 11 TÜR/DOOR 500x1125		1	500x1125	
	EL 12 Klappläden/Shutters		8	136x515	
FH1		FUNDAMENTHÖLZER (imprägniert)/FOUNDATION BEAMS (impregnated) 	5	40x30	1768
DT4		DECKENTRÄGER (Stütze für die Treppe und der Handlauf) (support for the ladder and railing) 	1	40x30	1326
LE1		LEISTE (für die Leiter) (for the ladder) 	2	28x95	1123
LE2		LEISTE (für die Leiter) (for the ladder) 	4	28x95	400
LE8		(Sprossen) (muntins) 	4+4	18x18	470
BK1		BLUMENKÄSTEN/FLOWER BOXES 	9	18x90	400
BK2		BLUMENKÄSTEN/FLOWER BOXES 	6	18x90	180
DB3		PFETTE/PURLIN 	1	44x94	2200
DB2		PFETTE/PURLIN 	1	44x94	1768
DB1		PFETTE/PURLIN 	1	18x90	2200
DB4		PFETTE/PURLIN 	1	18x90	2200
	Fussbodenbretter - Floor boards		16+1	113x16	2170
	Dachbretter - Roof boards		20+1	113x16	2010
	Dachbretter - Roof boards		20	113x16	1235
	Giebelzierbretter - Gable trim boards	33,9°  33,9°   ✓	1+1	120x18	1315
	Giebelzierbretter - Gable trim boards	39,4°  39,4°   ✓	1+1	120x18	2090
	Giebeldeckleisten - Gable cover strips	 ✓	2	40x18	1315
	Giebeldeckleisten - Gable cover strips	 ✓	2	40x18	2090
	Traufenleisten - Eaves strips		2	40x18	2200
Kood	Lola 220x180	Materjal	File	Lola 220x180 16.dwg	Leht 2/3

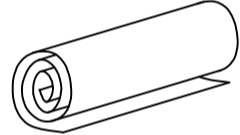
Pos	Teilleiste/Specification Lola 220x180 16		Stck Pcs.	Profil Profile (mm)	Länge Length (mm)
	Giebelsegment - Gable diamond		2		
W01	Winkel - Angle bracket 40x40x40		10		
H02	T-Scharnier - T-hinge 150mm KZN		2		
TK2	Türknoopf - Knob 02		2		
NG02	Nägel 2.0x40 (Fussbodenbretter, Dachbretter) Nails 2.0x40 (floor boards, roof boards)		360		
SR32	Schrauben 3.0x30 (Sprossen, Klapppläden, Giebeldeckleisten, Traufenleisten) Screws 3.0x30 (muntins, shutters, gable cover strips, eaves strips)		56		
SR37	Schrauben 3.5x45 (Blumenkästen, Giebelbretter, Giebelsegment) Screws 3.5x45 (flower boxes, gable boards, gable diamond)		66		
SR42	Schrauben 4.0x25ÜP (Winkel) Screws 4.0x25ÜP (angle bracket)		80		
SR44	Schrauben 4.0x60 (Wandelementen, die Leiter zu Balkon, Pfetten PF1/PF4) Screws 4.0x60 (Wall elements, ladder to balkony, purlins PF1/PF4)		50		
SR47	Schrauben 4.5x35ÜP (Blumenkästen zu der Wand) Screws 4.5x35ÜP (flower boxes to the wall)		12		
SR55	Schrauben 5.0x70 (Leiter Stufen) Screws 5.0x70 (ladder steps)		16		
NG01	Dachpappnägel 2.0x18 Roofing nails 2.0x18		180		
	Dachpappe - Roofing felt		✓	2,2m-4st.	9,0 lfm/rm
	✓ - Bitte selber anpassen (falls nötig)! / Cut into length on site (if needed)!				
Kood	Lola 220x180	Materjal	File	Lola 220x180 16.dwg	Leht 3/3

Wand/Wall 1

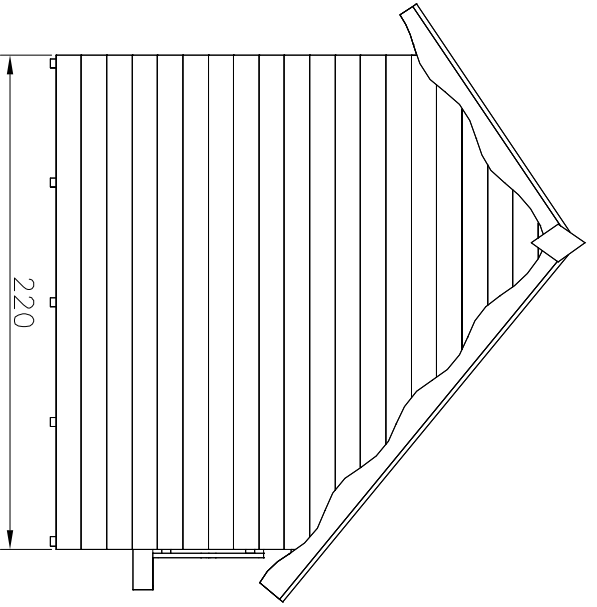

Wand/Wall 2

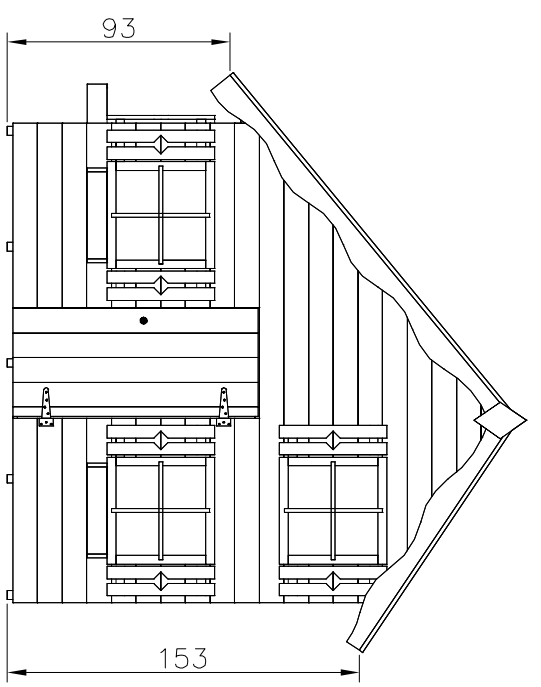

Wand/Wall A

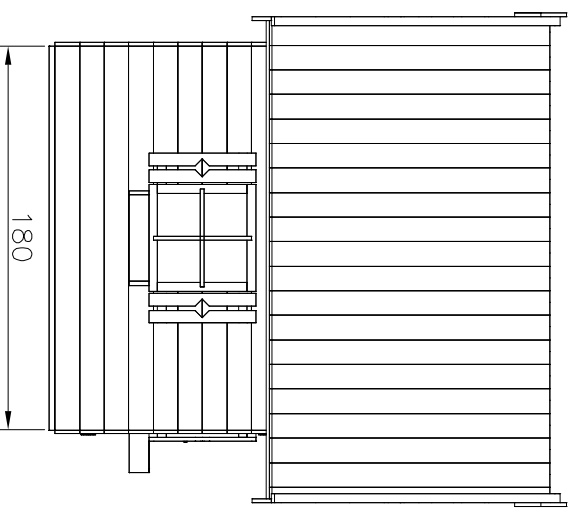

Wand/Wall B

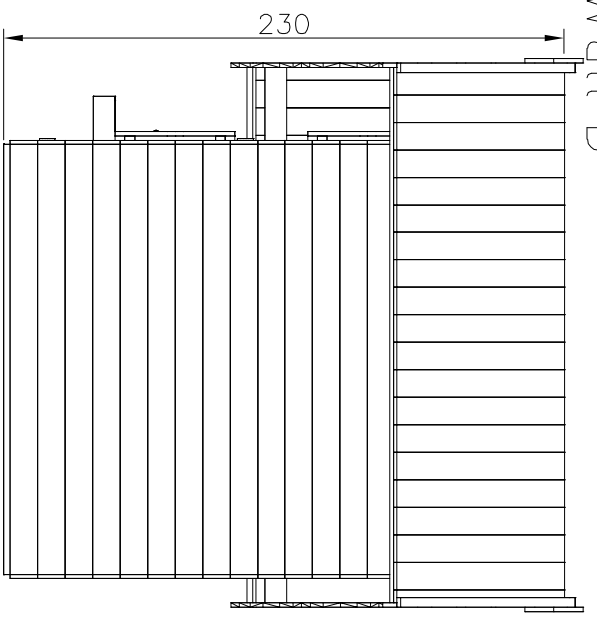

Loia 220x180 16

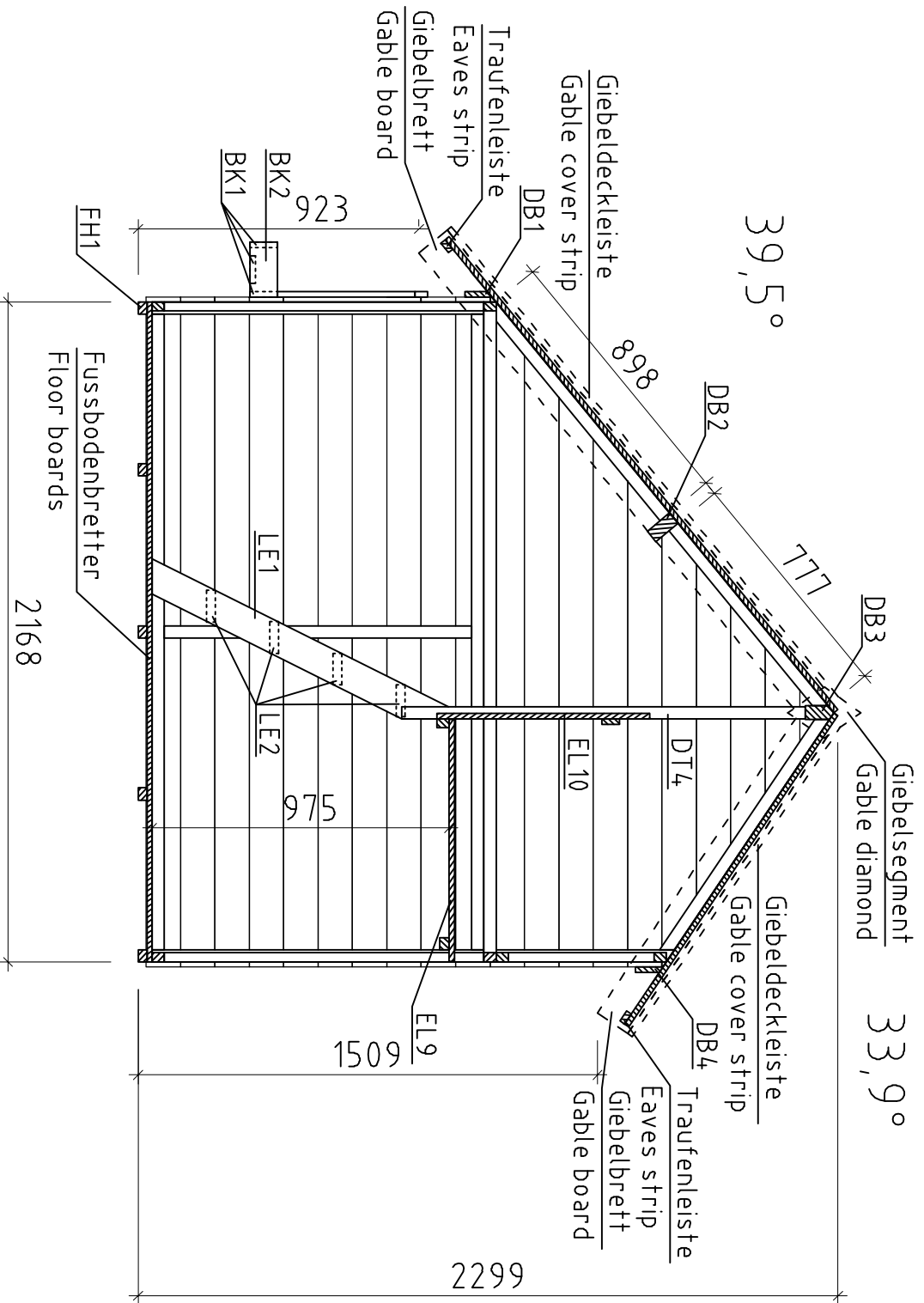

Lola 220x180 16

Schnitt/Section

1. Fussbodenbretter  
Floor boards

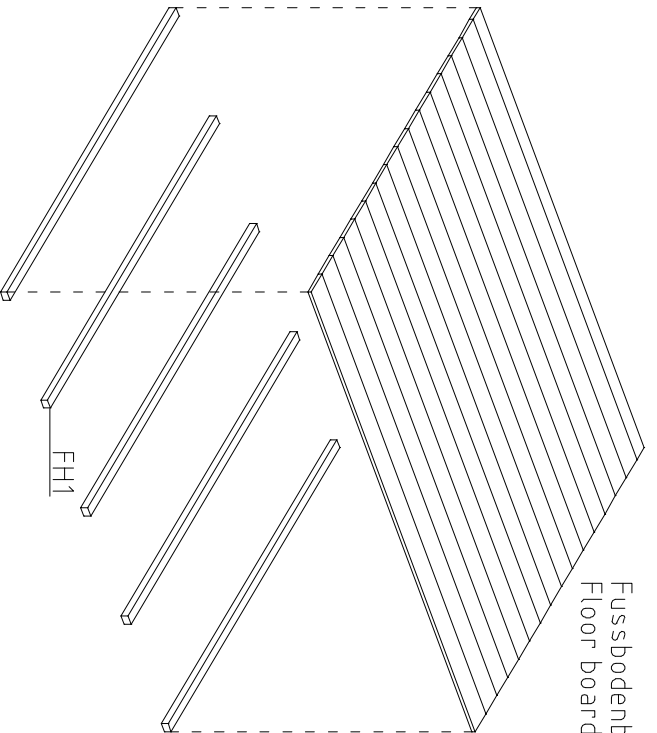

2.

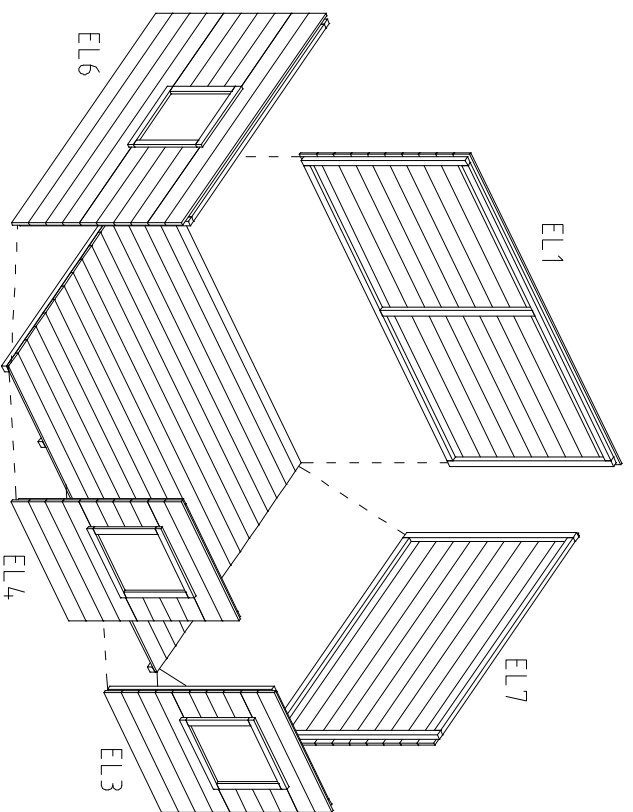

3.

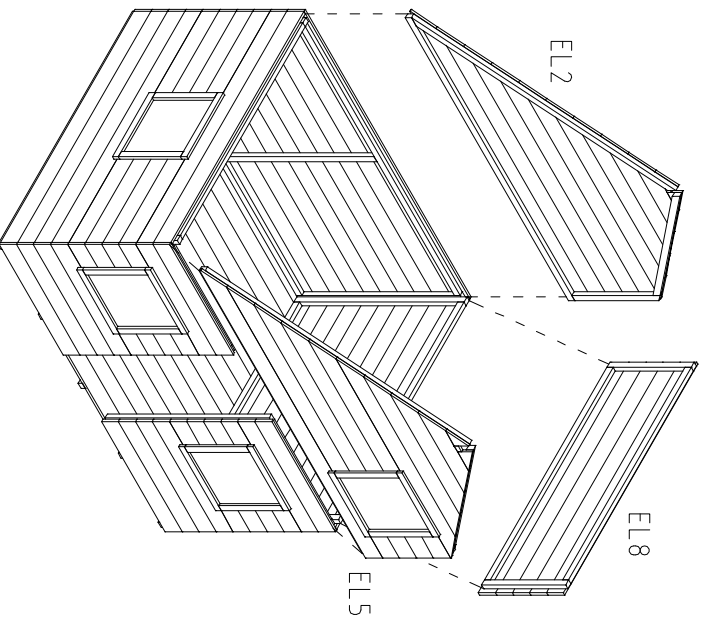

4.

